

8P025500

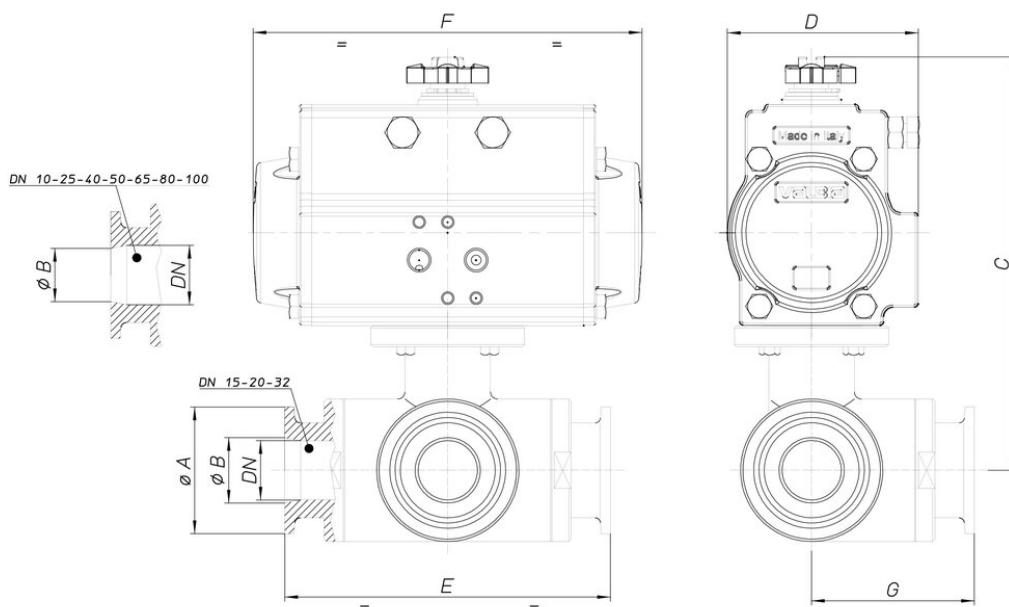

Valvola a sfera 3 vie ricavata da massello, 4 guarnizioni in P.T.F.E. vergine, lucida, acciaio inox AISI 316 passaggio totale e ridotto, sfera forata a 45° o 90°, attacchi clamp ISO 2852, DIN 32676 TAB.4 REIHE C per tubo BS/OD (ASTM A270).

Specifiche tecniche



MOD	PN	ØA	ØB	C	D	E	F	G	ACT.
8P02550003	40	25	9,7	148	71	108	141	54	DA 52
8P02550004	40	25	16	151	71	118	141	59	DA 52
8P02550005	40	51	22,2	170	81	130	164	65	DA 63
8P02550007	40	51	34,8	195	81	156	164	78	DA 63
8P02550010	25	64	47,5	237	106	182	241	91	DA 85
8P02550012	25	78	60,2	247	106	196	241	98	DA 85
8P02550014	16	91	72,6	274	123	256	275	128	DA 100
8P02550018	16	119	97,6	289	123	286	275	143	DA 100