

8P008500

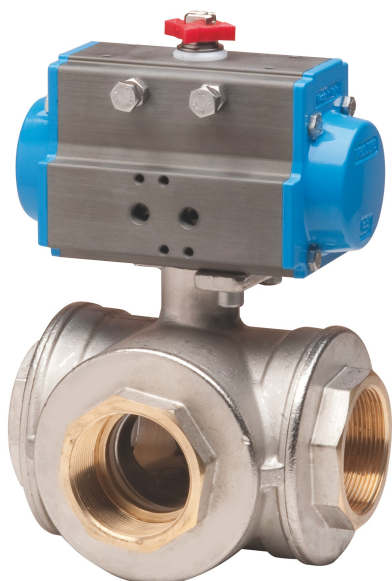

Valvola a sfera 3 vie [RB Artt. 3500 (T) - 3600 (L)], in ottone CW 617N con guarnizioni PTFE + VITON, filettata F/F/F, passaggio TOTALE, sfera forata a "T" o "L", con attuatore. Non idonea per solventi.

Specifiche tecniche

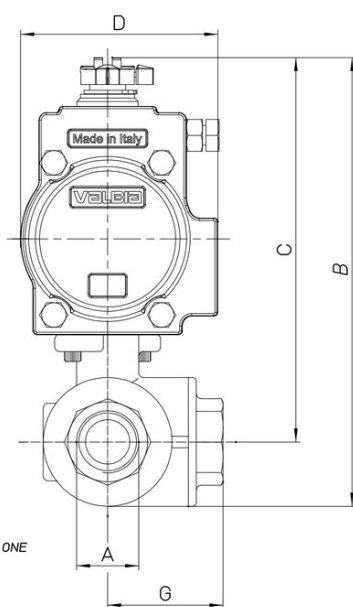
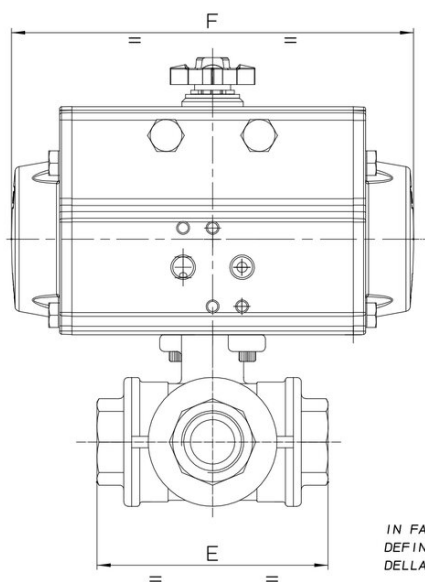

IN FASE D'ORDINE
DEFINIRE LA POSIZIONE
DELLA SFERA*

MOD	PN	A	B	C	D	E	F	G	ACT.	RI
8P00850002	30	1/4"	149	132	71	67	141	34	SR 52	3798
8P00850003	30	3/8"	149	132	71	67	141	34	SR 52	3798
8P00850004	30	1/2"	154	134	71	77	141	39	SR 52	3798
8P00850005	30	3/4"	179	155	81	87	164	44	SR 63	4025
8P00850006	16	1"	190	160	81	105	164	53	SR 63	4025
8P00850007	10	1"1/4	209	173	81	123	164	62	SR 63	4025
8P00850008	10	1"1/2	262	219	106	139	241	70	SR 85	4026
8P00850010	10	2"	299	243	123	166	275	83	SR 100	4026