

8P008400

Valvola a sfera 3 vie [RB Artt. 3500 (T) - 3600 (L)], in ottone CW 617N con guarnizioni PTFE + VITON, filettata F/F/F, passaggio TOTALE, sfera forata a "T" o "L", con attuatore. Non idonea per solventi.

Specifiche tecniche

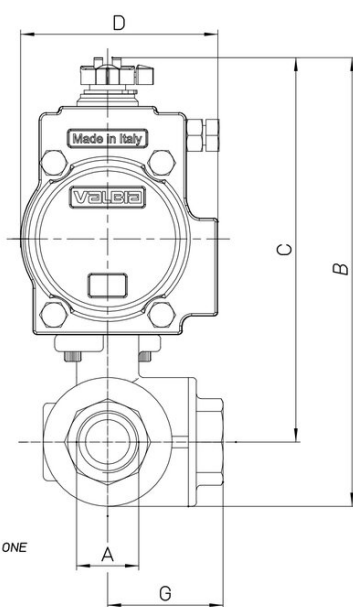
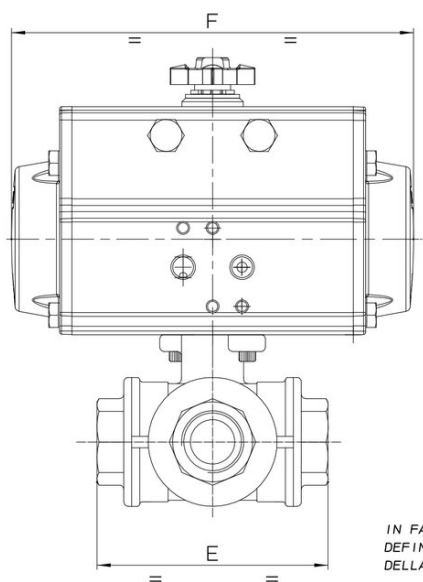

IN FASE D'ORDINE
DEFINIRE LA POSIZIONE
DELLA SFERA*

MOD	PN	A	B	C	D	E	F	G	ACT.	RI
8P00840002	30	1/4"	113	96	45	67	110	34	DA 32	4022
8P00840003	30	3/8"	113	96	45	67	110	34	DA 32	4022
8P00840004	30	1/2"	118	98	45	77	110	39	DA 32	4022
8P00840005	30	3/4"	167	143	71	87	141	44	DA 52	4023
8P00840006	16	1"	179	149	71	105	141	53	DA 52	4023
8P00840007	10	1"1/4	197	161	71	123	141	62	DA 52	4023
8P00840008	10	1"1/2	230	187	81	139	164	70	DA 63	4024
8P00840010	10	2"	272	216	95	166	210	83	DA 75	4026