

8P005800

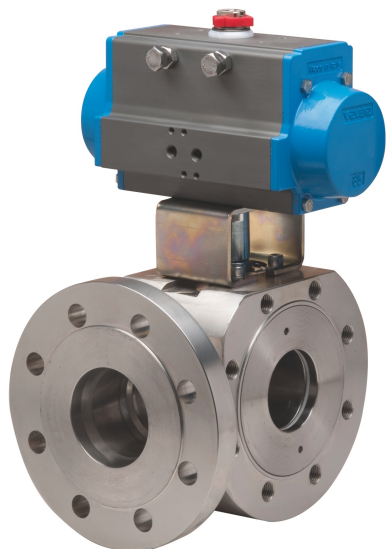

Valvola a sfera tipo "WAFER" (deviatore di flusso), [Valpres Artt. 776007 (L) - 776010 (T)], 3 vie, sfera forata a "L" o "T" con due guarnizioni, flangiata PN16, in acciaio inox AISI 316, passaggio RIDOTTO, con attuatore.

Specifiche tecniche

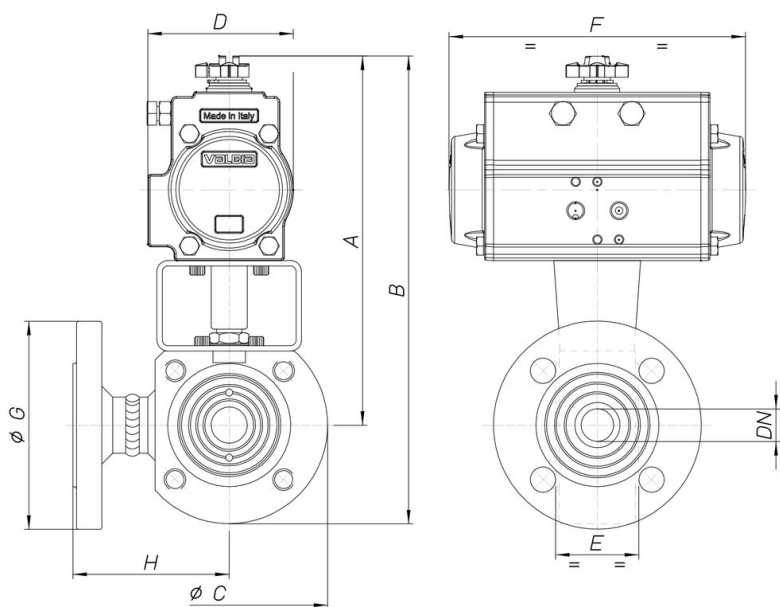

MOD	PN	A	B	Ø C	D	E	F	Ø G	H	ACT.	RI
8P00580004	16	183	228	89	71	40	141	95	76	SR 52	3780
8P00580005	16	199	249	99	81	40	164	105	82	SR 63	3014
8P00580006	16	204	259	109	81	46	164	115	86	SR 63	3007
8P00580007	16	212	277	130	81	58	164	140	105	SR 63	3048
8P00580008	16	259	329	140	106	71	241	150	110	SR 85	3009
8P00580010	16	278	358	160	123	82	275	165	120	SR 100	3009
8P00580012	16	349	439	180	137	106	333	185	125	SR 115	3010
8P00580014	16	370	470	200	148	122	372	200	150	SR 125	3010
8P00580018	16	387	497	220	148	152	372	220	159	SR 125	3005