

8P011500

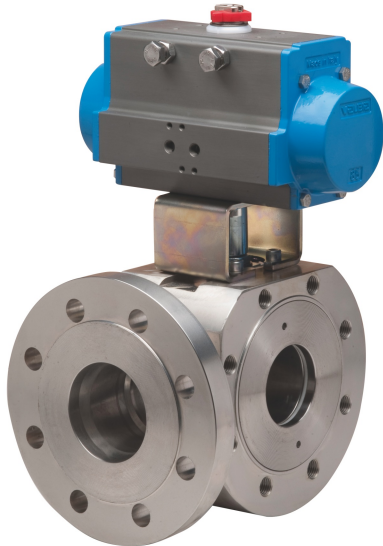

Valvola a sfera tipo "WAFER" (deviatore di flusso), [Valpres Artt. 776007 (L) - 776010 (T)], 3 vie, sfera forata a "L" o "T" con due guarnizioni, flangiata PN16, in acciaio inox AISI 316, passaggio RIDOTTO, con attuatore.

Specifiche tecniche

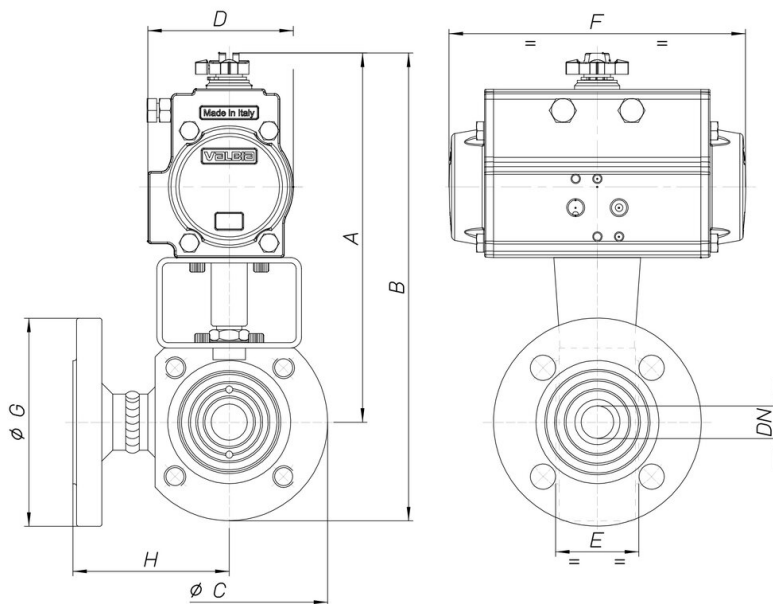

MOD	PN	A	B	Ø C	D	E	F	Ø G	H	ACT.	RI
8P01150004	16	147	191	89	45	40	110	95	76	DA 32	3012
8P01150005	16	189	239	99	71	40	141	105	82	DA 52	3013
8P01150006	16	193	248	109	71	46	141	115	86	DA 52	3001
8P01150007	16	200	265	130	71	58	141	140	105	DA 52	3008
8P01150008	16	227	297	140	81	71	164	150	110	DA 63	3002
8P01150010	16	251	331	160	95	82	210	165	120	DA 75	3009
8P01150012	16	282	372	180	106	106	241	185	125	DA 85	3003
8P01150014	16	290	390	200	106	122	241	200	150	DA 85	3003
8P01150018	16	340	450	220	123	152	275	220	159	DA 100	3004