

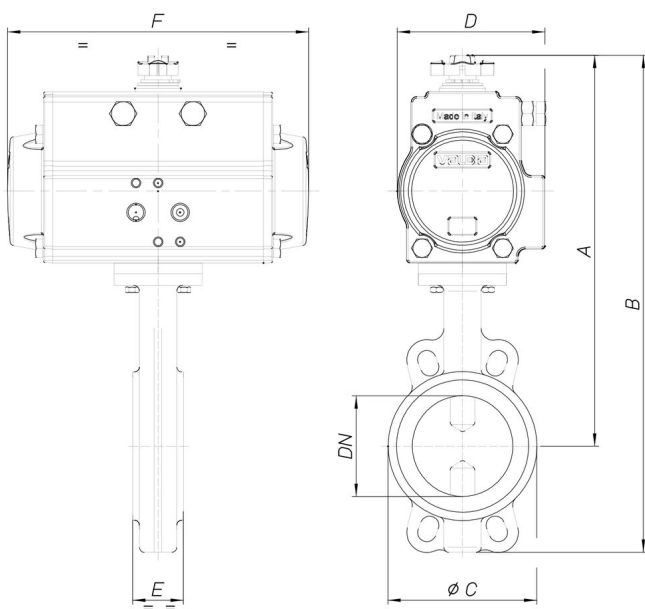

8P019800

Valvola a farfalla tipo Wafer PN16, (da DN32 a DN300)
 PN10 (da DN350 a DN600) corpo in ghisa
 GG25+vernice epossidica, disco in AISI 316 (da DN32 a
 DN300), guarnizione in EPDM [Valpres art. 600105] o
 NBR [Valpres art. 600119] da DN350 a DN600
 guarnizione in EPDM art. 905257.

Specifiche tecniche



MOD	PN	A	B	Ø C	D	E	F	ACT.	RI
8P01980007	16	231	290	85	81	33	164	SR 63	3883
8P01980008	16	235	305	95	81	33	164	SR 63	3843
8P01980010	16	266	338	100	81	43	164	SR 63	3843
8P01980012	16	279	357	120	81	46	164	SR 63	3843
8P01980014	16	312	401	127	106	46	241	SR 85	3844
8P01980018	16	328	430	161	106	52	241	SR 85	3840
8P01980019	16	354	477	190	123	56	275	SR 100	3846
8P01980020	16	398	536	215	137	56	333	SR 115	4450
8P01980021	16	493	661	268	186	60	500	SR 160	3848
8P01980077	16	524	731	325	186	68	500	SR 160	3867
8P01980078	16	697	940	375	217	78	579	SR 200	3309