

8P020100

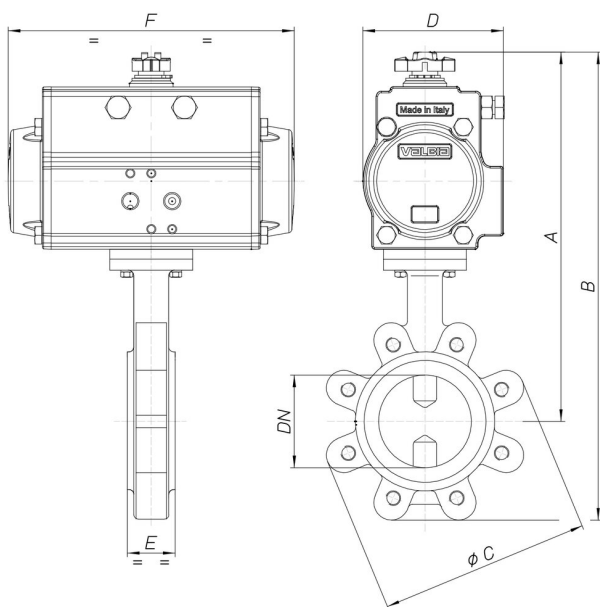

Valvola a farfalla tipo Lug PN16 (da DN50 a DN300), PN10 (da DN350 a DN600) corpo in ghisa GGG40+vernice epossidica, disco in GGG40 nichelato, da DN50 a DN300 guarnizione in EPDM [Valpres art. 600204] o NBR [Valpres art. 600231] da DN350 a DN600 in EPDM art. 905277.

Specifiche tecniche



MOD	PN	A	B	ØC	D	E	F	ACT.	RI
8P02010010	16	255	326	165	71	43	141	DA 52	3836
8P02010012	16	267	345	185	71	46	141	DA 52	3836
8P02010014	16	281	370	200	81	46	164	DA 63	3838
8P02010018	16	315	417	220	95	52	210	DA 75	3839
8P02010019	16	341	464	250	106	56	241	DA 85	3840
8P02010020	16	355	493	285	106	56	241	DA 85	3841
8P02010021	16	434	602	340	137	60	333	DA 115	3965
8P02010077	16	482	689	405	148	68	372	DA 125	3865
8P02010078	16	541	784	460	164	78	435	DA 140	3868