

8P020200

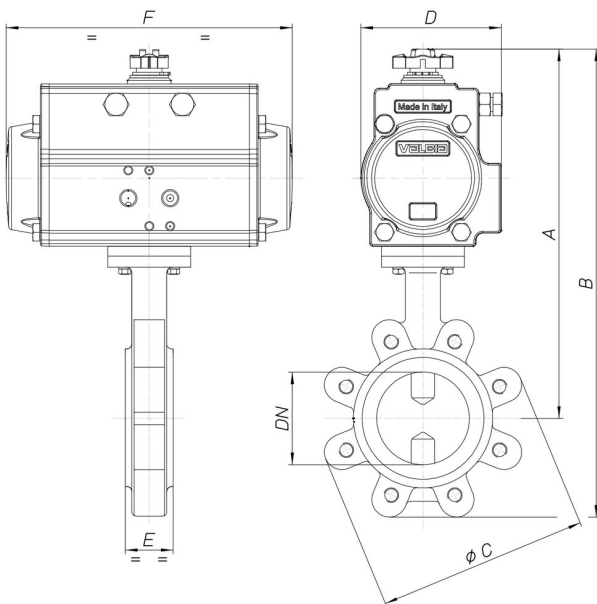

Valvola a farfalla tipo Lug PN16 (da DN50 a DN300), PN10 (da DN350 a DN600) corpo in ghisa GGG40+vernice epossidica, disco in GGG40 nichelato, da DN50 a DN300 guarnizione in EPDM [Valpres art. 600204] o NBR [Valpres art. 600231] da DN350 a DN600 in EPDM art. 905277.

Specifiche tecniche



MOD	PN	A	B	ØC	D	E	F	ACT.	RI
8P02020010	16	266	338	165	81	43	164	SR 63	3843
8P02020012	16	279	357	185	81	46	164	SR 63	3843
8P02020014	16	312	401	200	106	46	241	SR 85	3844
8P02020018	16	328	430	220	106	52	241	SR 85	3840
8P02020019	16	354	477	250	123	56	275	SR 100	3846
8P02020020	16	398	536	285	137	56	333	SR 115	4450
8P02020021	16	493	661	340	186	60	500	SR 160	3848
8P02020077	16	524	731	405	186	68	500	SR 160	3867
8P02020078	16	697	940	406	217	78	579	SR 200	3309