

8P028300

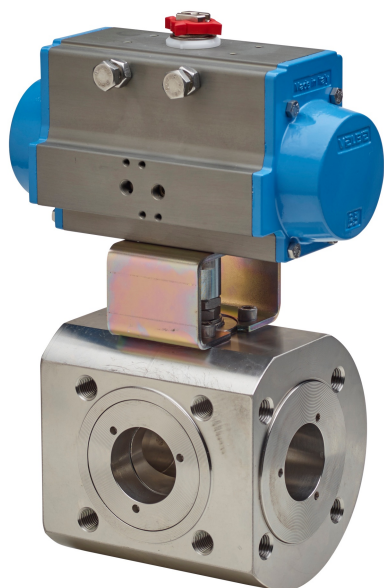

Valvola a sfera 3 vie [Valpres artt. 776400 (T) - 776401 (L)], con 4 guarnizioni, sfera forata a "T" o "L", flangiata PN16, acciaio inox AISI 316, passaggio totale con dispositivo antistatico.

Specifiche tecniche

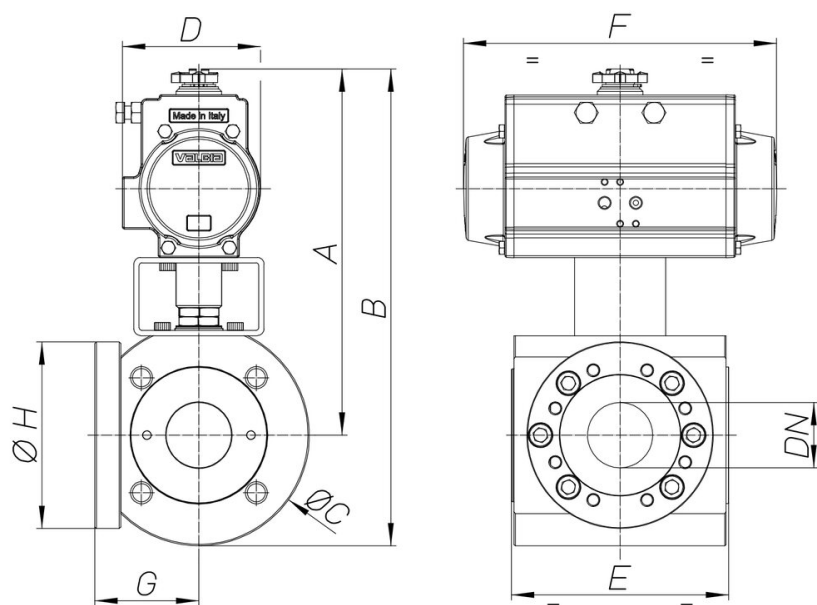

MOD	PN	A	B	ØC	D	E	F	G	ØH	ACT.	RI
8P02830004	16	187	231	88	71	99	141	35	/	DA 52	4408
8P02830005	16	217	267	100	81	108	164	40	/	DA 63	3563
8P02830006	16	222	277	109	81	115	164	41,5	/	DA 63	3563
8P02830007	16	253	318	133	95	140	210	52,5	/	DA 75	4410
8P02830008	16	260	335	150	95	150	210	56,5	/	DA 75	3522
8P02830010	16	282	367	168	106	167	241	62	/	DA 85	3522
8P02830012	16	306	411	208	123	185	275	85	/	DA 100	4411
8P02830014	16	380	495	229	137	216	333	127	212	DA 115	4412
8P02830018	16	376	515	278	137	244	333	150	239	DA 115	4412