

8P111200

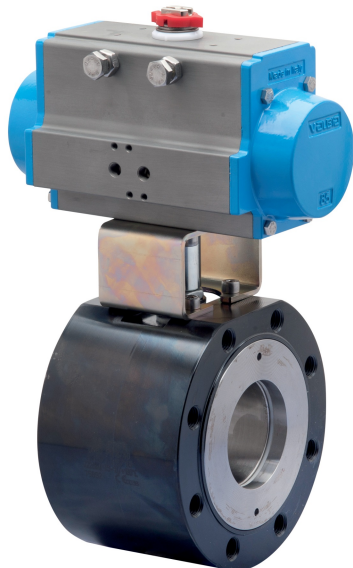

Valvola a sfera 2 vie [Valpres art.722V00 DN15 a DN100 (DN65 e DN100 solo PN16) art. 722V08 DN65 e DN100 solo PN40] flangiata PN16/40, tipo Wafer in acciaio al carbonio A105 a passaggio totale con tenuta asta V-Pack, scartamento secondo EN 558 series 100, Fire Safe, dispositivo antistatico.

NEW

Specifiche tecniche

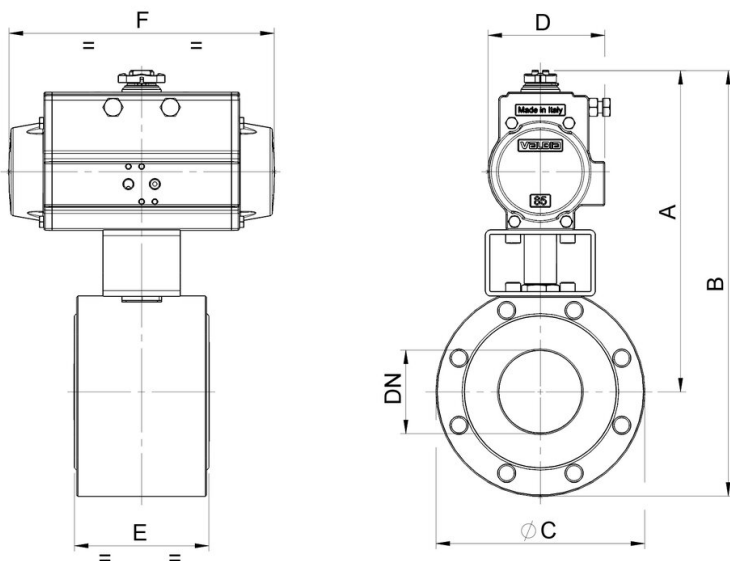

MOD	PN	A	B	C	D	E	F	ACT.	RI
8P11120004	16-40	186	231	95	71	36	141	SR 52	5344
8P11120005	16-40	202	252	105	81	39	164	SR 63	5346
8P11120006	16-40	210	265	115	81	44	164	SR 63	5347
8P11120007	16-40	214	279	140	81	52	164	SR 63	5347
8P11120008	16-40	267	337	150	81	64	241	SR 85	4117
8P11120010	16-40	288	363	165	123	83	275	SR 100	4117
8P11120012	16	335	425	185	137	105	333	SR 115	3527
8P11120014	40	335	425	185	137	105	333	SR 125	5347
8P11120018	16-40	353	448	200	148	121	372	SR 125	3528