

8E015

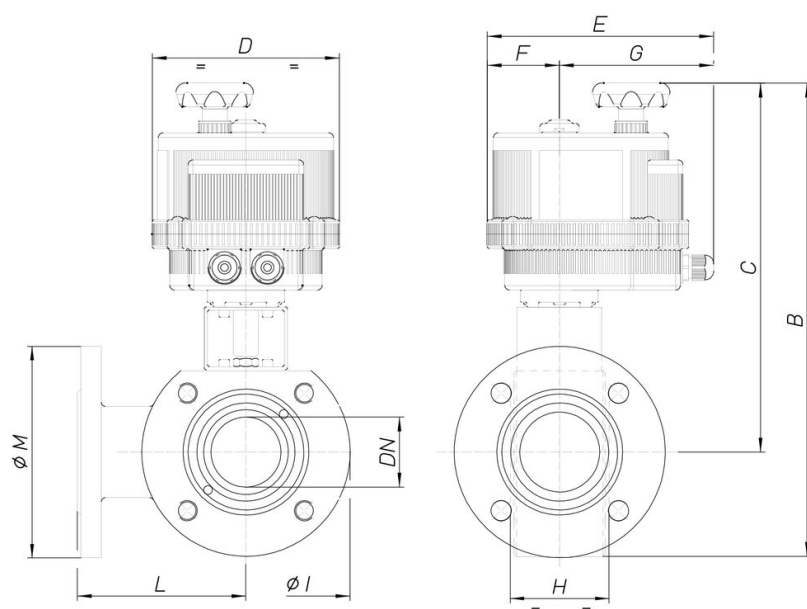

Valvola a sfera tipo "WAFER" (deviatore di flusso) [Valpres Art. 776000 (L) - Art.776001 (T)], 3 vie, sfera forata a "L" o "T" con due guarnizioni, flangiata PN16, in acciaio al carbonio ASTM A105, passaggio ridotto, con attuatore elettrico.

Specifiche tecniche



MOD	PN	B	C	D	E	F	G	H	ØI	L	ØM	ACT.	RI
8E01500104	16	268	224	123	164	43	121	40	89	76	95	VB 015	3780
8E01500204	16	268	224	123	164	43	121	40	89	76	95	VB 015	3780
8E01500404	16	268	224	123	164	43	121	40	89	76	95	VB 015	3780
8E01500105	16	278	228	123	164	43	121	40	99	82	105	VB 015	3013
8E01500205	16	278	228	123	164	43	121	40	99	82	105	VB 015	3013
8E01500405	16	278	228	123	164	43	121	40	99	82	105	VB 015	3013
8E01500106	16	334	279	157	191	61	130	46	109	86	115	VB 030	3001
8E01500206	16	334	279	157	191	61	130	46	109	86	115	VB 030	3001
8E01500406	16	334	279	157	191	61	130	46	109	86	115	VB 030	3001
8E01500107	16	352	287	157	191	61	130	58	130	100	140	VB 030	3008
8E01500207	16	352	287	157	191	61	130	58	130	100	140	VB 030	3008
8E01500407	16	352	287	157	191	61	130	58	130	100	140	VB 030	3008
8E01500108	16	399	329	185	215	68	147	71	140	105	150	VB 060	3002
8E01500208	16	399	329	185	215	68	147	71	140	105	150	VB 060	3002
8E01500408	16	399	329	185	215	68	147	71	140	105	150	VB 060	3002
8E01500110	16	415	335	185	215	68	147	82	160	115	165	VB 060	3002
8E01500210	16	415	335	185	215	68	147	82	160	115	165	VB 060	3002
8E01500410	16	415	335	185	215	68	147	82	160	115	165	VB 060	3002
8E01500112	16	459	369	211	237	84	153	106	180	125	185	VB 110	3003
8E01500212	16	459	369	211	237	84	153	106	180	125	185	VB 110	3003
8E01500412	16	459	369	211	237	84	153	106	180	125	185	VB 110	3003
8E01500114	16	477	377	211	237	84	153	122	200	150	200	VB 110	3003
8E01500214	16	477	377	211	237	84	153	122	200	150	200	VB 110	3003
8E01500414	16	477	377	211	237	84	153	122	200	150	200	VB 110	3003
8E01500118	16	524	414	211	237	84	153	152	220	159	220	VB 190	3004
8E01500218	16	524	414	211	237	84	153	152	220	159	220	VB 190	3004
8E01500418	16	524	414	211	237	84	153	152	220	159	220	VB 190	3004
8E01500119	16	562	437	211	237	84	153	196	250	190	250	VB 190	4558
8E01500219	16	562	437	211	237	84	153	196	250	190	250	VB 190	4558
8E01500419	16	562	437	211	237	84	153	196	250	190	250	VB 190	4558
8E01500120	16	609	456	222	247	77	170	242	306	210	285	VB 350	3042
8E01500220	16	609	456	222	247	77	170	242	306	210	285	VB 350	3042
8E01500420	16	609	456	222	247	77	170	242	306	210	285	VB 350	3042