

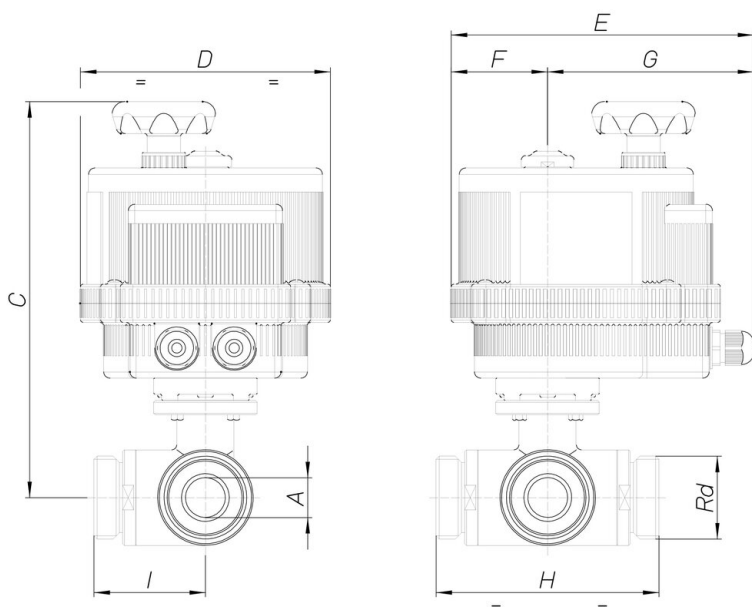

8E122

Valvola a sfera ricavata da massello, 3 vie, 4 guarnizioni PTFE vergine, lucida, acciaio inox AISI 316, attacchi DIN 11851 F/F/F, passaggio totale, sfera forata a "T" o "L", con attuatore elettrico.

Specifiche tecniche



MOD	PN	A	RD	C	D	E	F	G	H	I	ACT.
8E12200103	40	10	28x1/8"	188	123	163	43	121	108	54	VB 015
8E12200203	40	10	28x1/8"	188	123	163	43	121	108	54	VB 015
8E12200403	40	10	28x1/8"	188	123	163	43	121	108	54	VB 015
8E12200104	40	15	34x1/8"	191	123	163	43	121	118	59	VB 015
8E12200204	40	15	34x1/8"	191	123	163	43	121	118	59	VB 015
8E12200404	40	15	34x1/8"	191	123	163	43	121	118	59	VB 015
8E12200105	40	20	44x1/6"	245	157	190	61	130	130	65	VB 030 *
8E12200205	40	20	44x1/6"	245	157	190	61	130	130	65	VB 030 *
8E12200405	40	20	44x1/6"	245	157	190	61	130	130	65	VB 030 *
8E12200106	40	25	52x1/6"	249	157	190	61	130	140	70	VB 030 *
8E12200206	40	25	52x1/6"	249	157	190	61	130	140	70	VB 030 *
8E12200406	40	25	52x1/6"	249	157	190	61	130	140	70	VB 030 *
8E12200107	40	32	58x1/6"	297	185	214	68	147	156	78	VB 060
8E12200207	40	32	58x1/6"	297	185	214	68	147	156	78	VB 060
8E12200407	40	32	58x1/6"	297	185	214	68	147	156	78	VB 060
8E12200108	40	40	65x1/6"	304	185	214	68	147	172	86	VB 060*
8E12200208	40	40	65x1/6"	304	185	214	68	147	172	86	VB 060*
8E12200408	40	40	65x1/6"	304	185	214	68	147	172	86	VB 060*
8E12200110	25	50	78x1/6"	307	185	214	68	147	182	91	VB 060 *
8E12200210	25	50	78x1/6"	307	185	214	68	147	182	91	VB 060 *
8E12200410	25	50	78x1/6"	307	185	214	68	147	182	91	VB 060 *
8E12200112	25	65	95x1/6"	334	211	237	84	153	196	98	VB 110
8E12200212	25	65	95x1/6"	334	211	237	84	153	196	98	VB 110
8E12200412	25	65	95x1/6"	334	211	237	84	153	196	98	VB 110
8E12200114	16	80	110x1/4"	349	211	237	84	153	256	128	VB 190
8E12200214	16	80	110x1/4"	349	211	237	84	153	256	128	VB 190
8E12200414	16	80	110x1/4"	349	211	237	84	153	256	128	VB 190
8E12200118	16	100	130x1/4"	365	222	247	77	170	286	143	VB 350
8E12200218	16	100	130x1/4"	365	222	247	77	170	286	143	VB 350
8E12200418	16	100	130x1/4"	365	222	247	77	170	286	143	VB 350