

## 8E022

Valvola a sfera ricavata da massello, 3 vie, lucida, acciaio inox AISI 316, flangiata, passaggio totale, sfera a "T" o "L", con attuatore elettrico.

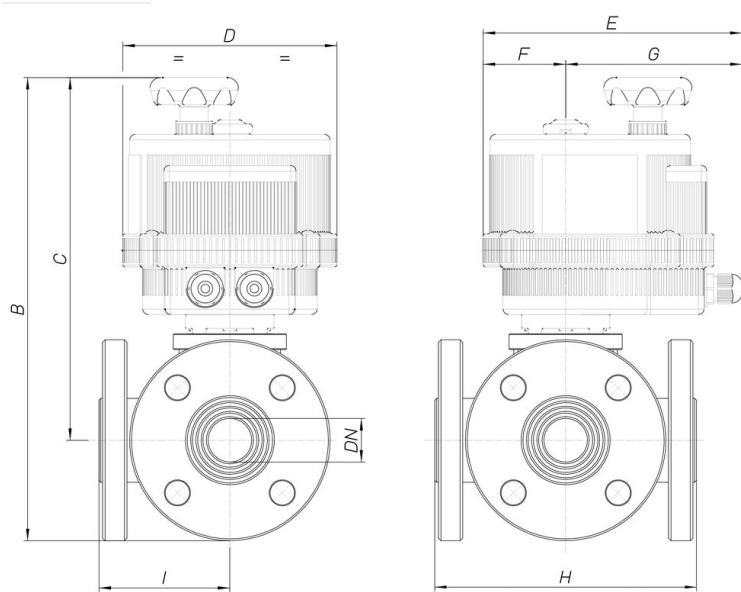

### Specifiche tecniche



MOD	PN	B	C	D	E	F	G	H	I	ACT.
8E02200103	40	234	189	123	164	43	121	120	60	VB 015
8E02200203	40	234	189	123	164	43	121	120	60	VB 015
8E02200403	40	234	189	123	164	43	121	120	60	VB 015
8E02200104	40	239	191	123	164	43	121	130	65	VB 015
8E02200204	40	239	191	123	164	43	121	130	65	VB 015
8E02200404	40	239	191	123	164	43	121	130	65	VB 015
8E02200105	40	297	245	157	191	61	130	140	70	VB 030 *
8E02200205	40	297	245	157	191	61	130	140	70	VB 030 *
8E02200405	40	297	245	157	191	61	130	140	70	VB 030 *
8E02200106	40	307	249	157	191	61	130	150	75	VB 030 *
8E02200206	40	307	249	157	191	61	130	150	75	VB 030 *
8E02200406	40	307	249	157	191	61	130	150	75	VB 030 *
8E02200107	40	367	297	185	215	68	147	180	90	VB 060
8E02200207	40	367	297	185	215	68	147	180	90	VB 060
8E02200407	40	367	297	185	215	68	147	180	90	VB 060
8E02200108	40	379	304	185	215	68	147	200	100	VB 060
8E02200208	40	379	304	185	215	68	147	200	100	VB 060
8E02200408	40	379	304	185	215	68	147	200	100	VB 060
8E02200110	25	389	307	185	215	68	147	220	110	VB 060 *
8E02200210	25	389	307	185	215	68	147	220	110	VB 060 *
8E02200410	25	389	307	185	215	68	147	220	110	VB 060 *
8E02200112	16	426	334	211	237	84	153	240	120	VB 110
8E02200212	16	426	334	211	237	84	153	240	120	VB 110
8E02200412	16	426	334	211	237	84	153	240	120	VB 110
8E02200114	16	448	348	211	237	84	153	260	130	VB 190
8E02200214	16	448	348	211	237	84	153	260	130	VB 190
8E02200414	16	448	348	211	237	84	153	260	130	VB 190
8E02200118	16	475	365	222	247	77	170	300	150	VB 350
8E02200218	16	475	365	222	247	77	170	300	150	VB 350
8E02200418	16	475	365	222	247	77	170	300	150	VB 350