

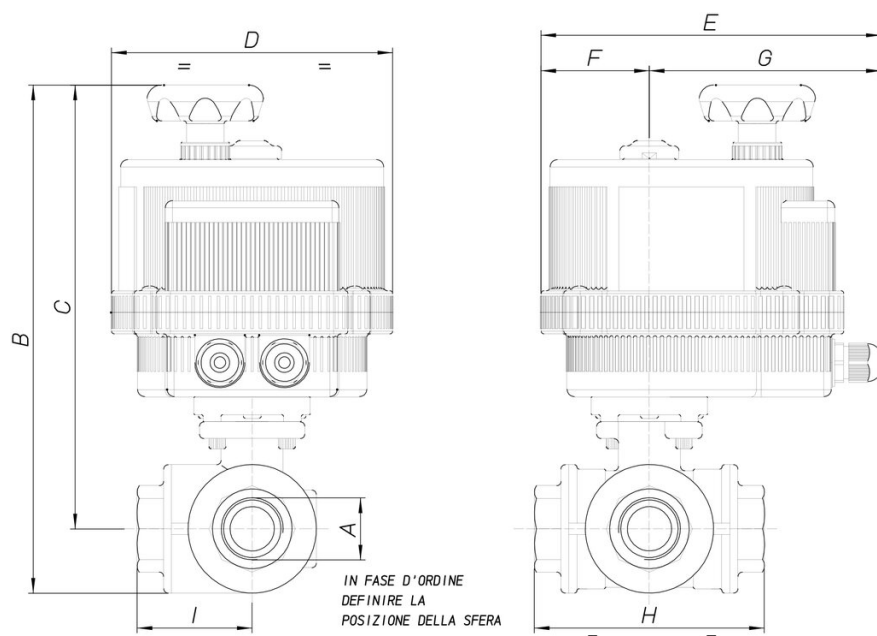

## 8E029

Valvola a sfera 3 vie [RB Artt. 3500 (T) - 3600 (L)], in ottone CW617N con guarnizioni PTFE + VITON, filettata F/F/F, passaggio totale, sfera forata a "T" o "L", con attuatore elettrico. Non idonea per solventi.

### Specifiche tecniche



MOD	PN	A	B	C	D	E	F	G	H	I	ACT.	RI
8E02900102	30	1/4"	190	173	123	164	43	121	67	34	VB 015	3798
8E02900202	30	1/4"	190	173	123	164	43	121	67	34	VB 015	3798
8E02900402	30	1/4"	190	173	123	164	43	121	67	34	VB 015	3798
8E02900103	30	3/8"	190	173	123	164	43	121	67	34	VB 015	3798
8E02900203	30	3/8"	190	173	123	164	43	121	67	34	VB 015	3798
8E02900403	30	3/8"	190	173	123	164	43	121	67	34	VB 015	3798
8E02900104	30	1/2"	195	175	123	164	43	121	77	39	VB 015	3798
8E02900204	30	1/2"	195	175	123	164	43	121	77	39	VB 015	3798
8E02900404	30	1/2"	195	175	123	164	43	121	77	39	VB 015	3798
8E02900105	30	3/4"	208	184	123	164	43	121	87	44	VB 015	4023
8E02900205	30	3/4"	208	184	123	164	43	121	87	44	VB 015	4023
8E02900405	30	3/4"	208	184	123	164	43	121	87	44	VB 015	4023
8E02900106	16	1"	265	235	157	191	61	130	105	53	VB 030	4023
8E02900206	16	1"	265	235	157	191	61	130	105	53	VB 030	4023
8E02900406	16	1"	265	235	157	191	61	130	105	53	VB 030	4023
8E02900107	10	1"1/4	284	248	157	191	61	130	123	62	VB 030	4023
8E02900207	10	1"1/4	284	248	157	191	61	130	123	62	VB 030	4023
8E02900407	10	1"1/4	284	248	157	191	61	130	123	62	VB 030	4023
8E02900108	10	1"1/2	332	289	185	215	68	147	139	70	VB 060	4024
8E02900208	10	1"1/2	332	289	185	215	68	147	139	70	VB 060	4024
8E02900408	10	1"1/2	332	289	185	215	68	147	139	70	VB 060	4024
8E02900110	10	2"	356	300	185	215	68	147	166	83	VB 060	4024
8E02900210	10	2"	356	300	185	215	68	147	166	83	VB 060	4024
8E02900410	10	2"	356	300	185	215	68	147	166	83	VB 060	4024