

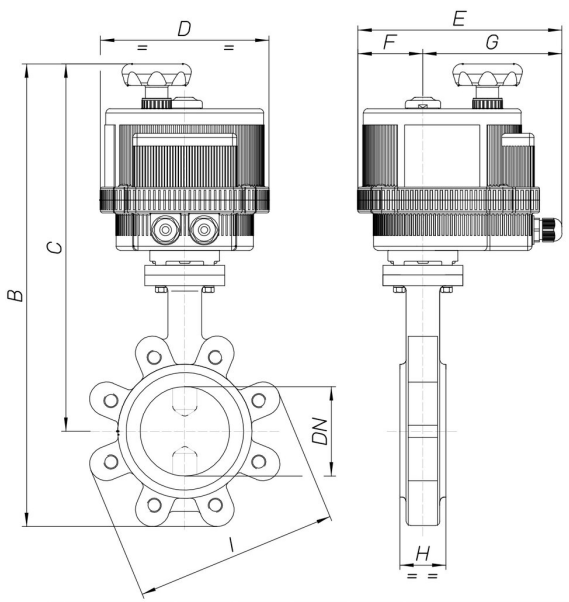

8E038

Valvola a farfalla tipo Lug PN16 (da DN50 a DN300), PN10 (da DN350 a DN600) corpo in ghisa GGG40+vernice epossidica, disco in GGG40 nichelato, da DN50 a DN300 guarnizione in EPDM [Valpres art. 600204] o NBR [Valpres art. 600231] da DN350 a DN600 in EPDM art. 905277, con attuatore elettrico serie 85.

Specifiche tecniche



MOD	PN	B	C	D	E	F	G	H	I	ACT.	RI
8E03800110	16	413	341	157	191	61	130	43	165	VB 030	3836
8E03800210	16	413	341	157	191	61	130	43	165	VB 030	3836
8E03800410	16	413	341	157	191	61	130	43	165	VB 030	3836
8E03800112	16	432	354	157	191	61	130	46	185	VB 030	3836
8E03800212	16	432	354	157	191	61	130	46	185	VB 030	3836
8E03800412	16	432	354	157	191	61	130	46	185	VB 030	3836
8E03800114	16	472	382	185	215	68	147	46	200	VB 060	3883
8E03800214	16	472	382	185	215	68	147	46	200	VB 060	3883
8E03800414	16	472	382	185	215	68	147	46	200	VB 060	3883
8E03800118	16	500	398	185	215	68	147	52	220	VB 060	3884
8E03800218	16	500	398	185	215	68	147	52	220	VB 060	3884
8E03800418	16	500	398	185	215	68	147	52	220	VB 060	3884
8E03800119	16	551	428	211	237	84	153	56	250	VB 110	3840
8E03800219	16	551	428	211	237	84	153	56	250	VB 110	3840
8E03800419	16	551	428	211	237	84	153	56	250	VB 110	3840
8E03800120	16	579	441	211	237	84	153	56	285	VB 190	3847
8E03800220	16	579	441	211	237	84	153	56	285	VB 190	3847
8E03800420	16	579	441	211	237	84	153	56	285	VB 190	3847
8E03800121	16	644	476	222	247	77	170	60	340	VB 270	3965
8E03800221	16	644	476	222	247	77	170	60	340	VB 270	3965
8E03800421	16	644	476	222	247	77	170	60	340	VB 270	3965
8E03800177	16	719	512	222	247	77	170	68	405	VB 350	3865
8E03800277	16	719	512	222	247	77	170	68	405	VB 350	3865
8E03800477	16	719	512	222	247	77	170	68	405	VB 350	3865