

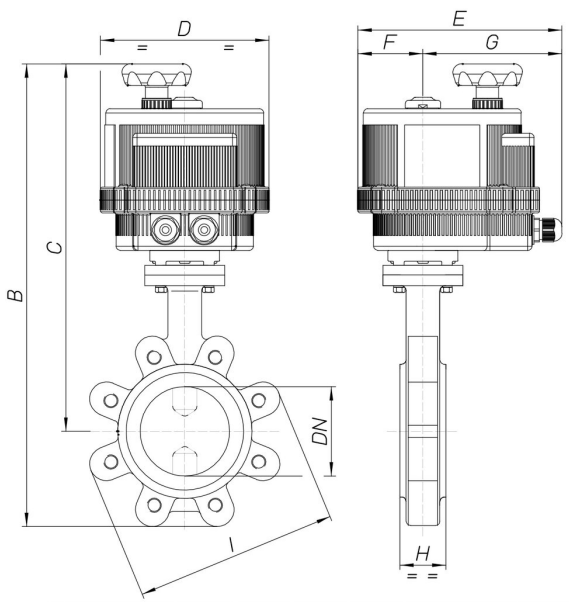

## 8E102

Valvola a farfalla tipo "LUG" PN16, corpo in ghisa GGG40 + vernice epossidica, disco AISI 316, guarnizione in EPDM [Valpres Art. 600205] o NBR [Valpres Art. 600230], con attuatore elettrico.

### Specifiche tecniche



MOD	PN	B	C	D	E	F	G	H	I	ACT.	RI
8E10200108	16	334	264	123	164	43	121	33	145	VB 015	3836
8E10200208	16	334	264	123	164	43	121	33	145	VB 015	3836
8E10200408	16	334	264	123	164	43	121	33	145	VB 015	3836
8E10200110	16	413	341	157	191	61	130	43	165	VB 030	3836
8E10200210	16	413	341	157	191	61	130	43	165	VB 030	3836
8E10200410	16	413	341	157	191	61	130	43	165	VB 030	3836
8E10200112	16	432	354	157	191	61	130	46	185	VB 030	3836
8E10200212	16	432	354	157	191	61	130	46	185	VB 030	3836
8E10200412	16	432	354	157	191	61	130	46	185	VB 030	3836
8E10200114	16	472	382	185	215	68	147	46	200	VB 060	3883
8E10200214	16	472	382	185	215	68	147	46	200	VB 060	3883
8E10200414	16	472	382	185	215	68	147	46	200	VB 060	3883
8E10200118	16	500	398	185	215	68	147	52	220	VB 060	3884
8E10200218	16	500	398	185	215	68	147	52	220	VB 060	3884
8E10200418	16	500	398	185	215	68	147	52	220	VB 060	3884
8E10200119	16	551	428	211	237	84	153	56	250	VB 110	3840
8E10200219	16	551	428	211	237	84	153	56	250	VB 110	3840
8E10200419	16	551	428	211	237	84	153	56	250	VB 110	3840
8E10200120	16	579	441	211	237	84	153	56	285	VB 190	3847
8E10200220	16	579	441	211	237	84	153	56	285	VB 190	3847
8E10200420	16	579	441	211	237	84	153	56	285	VB 190	3847
8E10200121	16	644	476	222	247	77	170	60	340	VB 270	3965
8E10200221	16	644	476	222	247	77	170	60	340	VB 270	3965
8E10200421	16	644	476	222	247	77	170	60	340	VB 270	3965
8E10200177	16	719	512	222	247	77	170	68	405	VB 350	3865
8E10200277	16	719	512	222	247	77	170	68	405	VB 350	3865
8E10200477	16	719	512	222	247	77	170	68	405	VB 350	3865