

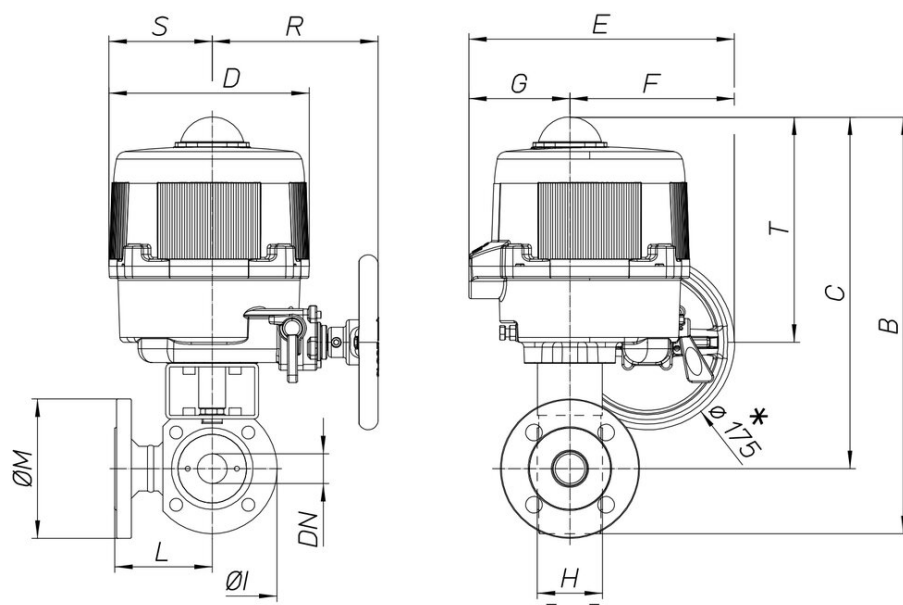

8M013

Valvola a sfera 3 vie tipo Wafer deviatore di flusso
[Valpres artt. 776001 (T) - 776000 (L)] con 2 guarnizioni,
sfera forata a T o L, flangiata PN16, acciaio al carbonio
ASTM A105, passaggio ridotto.

Specifiche tecniche



MOD	PN	B	C	D	E	F	G	H	ØI	L	ØM	R	S	T	ACT.	RI
8M01300106	16	345	290	161	187	63	124	46	109	86	115	-	-	-	VB 030M	3001
8M01300206	16	345	290	161	187	63	124	46	109	86	115	-	-	-	VB 030M	3001
8M01300406	16	345	290	161	187	63	124	46	109	86	115	-	-	-	VB 030M	3001
8M01300107	16	363	298	161	187	63	124	58	130	105	140	-	-	-	VB 030M	3008
8M01300207	16	363	298	161	187	63	124	58	130	105	140	-	-	-	VB 030M	3008
8M01300407	16	363	298	161	187	63	124	58	130	105	140	-	-	-	VB 030M	3008
8M01300108	16	404	334	176	197	63	134	71	140	110	150	-	-	-	VB 060M	3002
8M01300208	16	404	334	176	197	63	134	71	140	110	150	-	-	-	VB 060M	3002
8M01300408	16	404	334	176	197	63	134	71	140	110	150	-	-	-	VB 060M	3002
8M01300110	16	420	340	176	197	63	134	82	160	115	165	-	-	-	VB 060M	3002
8M01300210	16	420	340	176	197	63	134	82	160	115	165	-	-	-	VB 060M	3002
8M01300410	16	420	340	176	197	63	134	82	160	115	165	-	-	-	VB 060M	3002
8M01300112	16	473	383	200	266	165	101	106	180	125	185	167	103	225	VB 110M	3003
8M01300212	16	473	383	200	266	165	101	106	180	125	185	167	103	225	VB 110M	3003
8M01300412	16	473	383	200	266	165	101	106	180	125	185	167	103	225	VB 110M	3003
8M01300114	16	491	391	200	266	165	101	122	200	150	200	167	103	225	VB 110M	3003
8M01300214	16	491	391	200	266	165	101	122	200	150	200	167	103	225	VB 110M	3003
8M01300414	16	491	391	200	266	165	101	122	200	150	200	167	103	225	VB 110M	3003
8M01300118	16	538	428	200	266	165	101	152	220	159	220	167	103	225	VB 190M	3004
8M01300218	16	538	428	200	266	165	101	152	220	159	220	167	103	225	VB 190M	3004
8M01300418	16	538	428	200	266	165	101	152	220	159	220	167	103	225	VB 190M	3004
8M01300119	16	578	454	200	266	165	101	196	250	190	250	167	103	225	VB 190M	4558
8M01300219	16	578	454	200	266	165	101	196	250	190	250	167	103	225	VB 190M	4558
8M01300419	16	578	454	200	266	165	101	196	250	190	250	167	103	225	VB 190M	4558
8M01300120	16	630	454	212	279	184	95	242	306	210	285	166	109	226	VB 350M	3042
8M01300220	16	630	454	212	279	184	95	242	306	210	285	166	109	226	VB 350M	3042
8M01300420	16	630	454	212	279	184	95	242	306	210	285	166	109	226	VB 350M	3042