

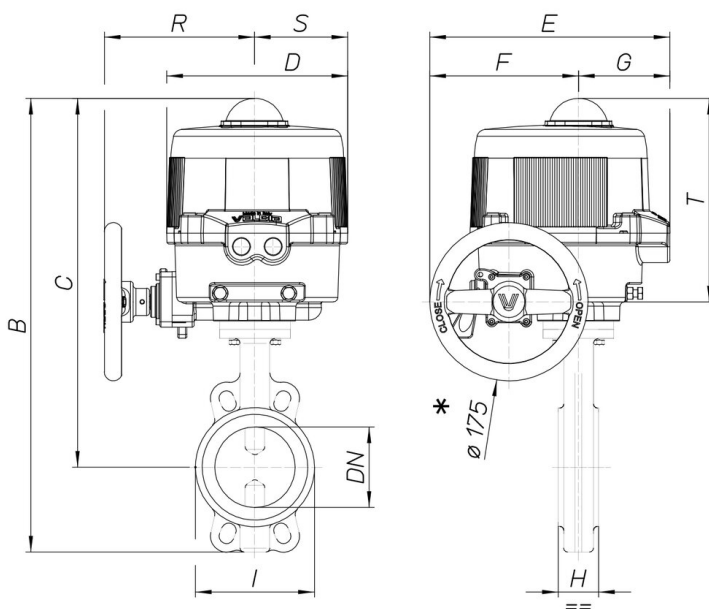

8M034

Valvola a farfalla tipo Wafer PN16 (da DN50 a DN300), PN10 (da DN350 a DN600) corpo in ghisa GG25+vernice epossidica, disco in GGG40 nichelato, da DN50 a DN300 guarnizione in EPDM [Valpres art. 600104] o NBR [Valpres art. 600117] da DN350 a DN600 guarnizione in EPDM art. 905276.

Specifiche tecniche



MOD	PN	B	C	D	E	F	G	H	I	R	S	T	ACT.	KIT
8M03400110	16	424	352	161	187	63	124	43	100	-	-	-	VB030M	RI3836
8M03400210	16	424	352	161	187	63	124	43	100	-	-	-	VB030M	RI3836
8M03400410	16	424	352	161	187	63	124	43	100	-	-	-	VB030M	RI3836
8M03400112	16	443	365	161	187	63	124	46	120	-	-	-	VB030M	RI3836
8M03400212	16	443	365	161	187	63	124	46	120	-	-	-	VB030M	RI3836
8M03400412	16	443	365	161	187	63	124	46	120	-	-	-	VB030M	RI3836
8M03400114	16	477	387	176	197	63	134	46	127	-	-	-	VB060M	RI3883
8M03400214	16	477	387	176	197	63	134	46	127	-	-	-	VB060M	RI3883
8M03400414	16	477	387	176	197	63	134	46	127	-	-	-	VB060M	RI3883
8M03400118	16	505	403	176	197	63	134	52	161	-	-	-	VB060M	RI3884
8M03400218	16	505	403	176	197	63	134	52	161	-	-	-	VB060M	RI3884
8M03400418	16	505	403	176	197	63	134	52	161	-	-	-	VB060M	RI3884
8M03400119	16	565	442	200	266	165	101	56	190	167	103	225	VB110M	RI3840
8M03400219	16	565	442	200	266	165	101	56	190	167	103	225	VB110M	RI3840
8M03400419	16	565	442	200	266	165	101	56	190	167	103	225	VB110M	RI3840
8M03400120	16	593	455	200	266	165	101	56	512	167	103	225	VB190M	RI3847
8M03400220	16	593	455	200	266	165	101	56	512	167	103	225	VB190M	RI3847
8M03400420	16	593	455	200	266	165	101	56	512	167	103	225	VB190M	RI3847
8M03400121	16	658	490	212	279	184	95	60	568	166	109	226	VB270M	RI3965
8M03400221	16	658	490	212	279	184	95	60	568	166	109	226	VB270M	RI3965
8M03400421	16	658	490	212	279	184	95	60	568	166	109	226	VB270M	RI3965
8M03400177	16	733	526	212	279	184	95	68	325	166	109	226	VB350M	RI3865
8M03400277	16	733	526	212	279	184	95	68	325	166	109	226	VB350M	RI3865
8M03400477	16	733	526	212	279	184	95	68	325	166	109	226	VB350M	RI3865