

8M130

Valvola a sfera 3 vie deviatrice in acciaio inox AISI 316L, con sfera forata a T o L, filettata F/F/F per alta pressione, idonee per olio (idraulico ecc...), emulsione, gas metano. Per applicazioni particolari consultare l'ufficio commerciale.

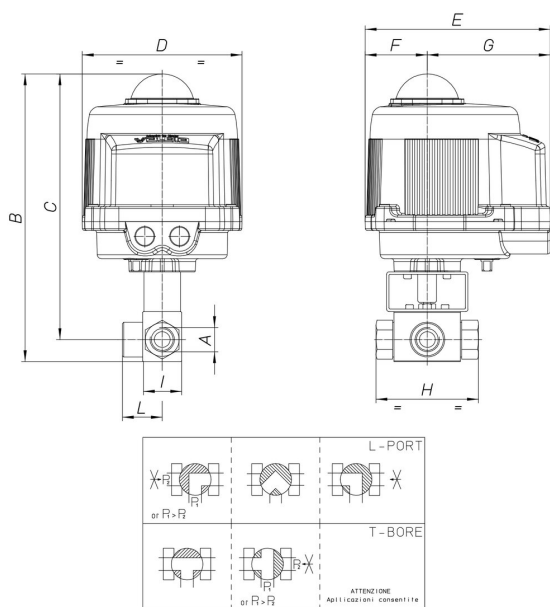

Specifiche tecniche



MOD	PN	B	C	D	E	F	G	H	I	L	ACT.	KIT
8M13000103	400	279	261	161	187	63	124	73	35	37	VB030M	RI3740
8M13000203	400	279	261	161	187	63	124	73	35	37	VB030M	RI3740
8M13000403	400	279	261	161	187	63	124	73	35	37	VB030M	RI3740
8M13000104	350	282	264	161	187	63	124	83	37	40	VB030M	RI3740
8M13000204	350	282	264	161	187	63	124	83	37	40	VB030M	RI3740
8M13000404	350	282	264	161	187	63	124	83	37	40	VB030M	RI3740
8M13000105	350	294	271	161	187	63	124	95	45	52	VB030M	RI4037
8M13000205	350	294	271	161	187	63	124	95	45	52	VB030M	RI4037
8M13000405	350	294	271	161	187	63	124	95	45	52	VB030M	RI4037
8M13000106	350	325	296	176	197	63	134	112	55	60	VB060M	RI4038
8M13000206	350	325	296	176	197	63	134	112	55	60	VB060M	RI4038
8M13000406	350	325	296	176	197	63	134	112	55	60	VB060M	RI4038